

PLAN

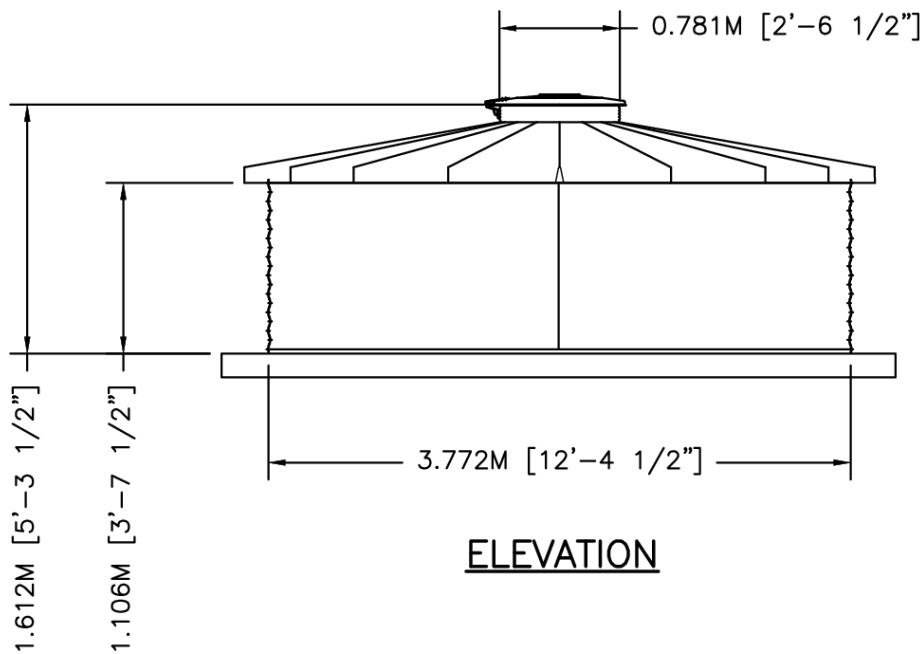

ELEVATION



	BY	DATE	TITLE	
DWN	XXX	XX/XX/XX	WTU04-01 30"PR 10DEG V-RIB	
CKD			NOMINAL CAPACITY - 10.924 M3 [2,886 GAL]	
ENG			DWG. NO. SCT1201-LVR WTU04-01	REV. NO.
SIZE: A		SCALE: 1/4"=1'-0"		SHEET 1 OF 1